

Catalytic Emission Control Technologies for Automotive Emissions

(Mainly, LDT vehicles)

Typical Position of TWCs

Ultra Low Emission Vehicles
(ULEVs)

CCC: Close-coupled Catalytic Converter
UCC: Underbody Catalytic Converter
MCC: Manifold Catalytic Converter

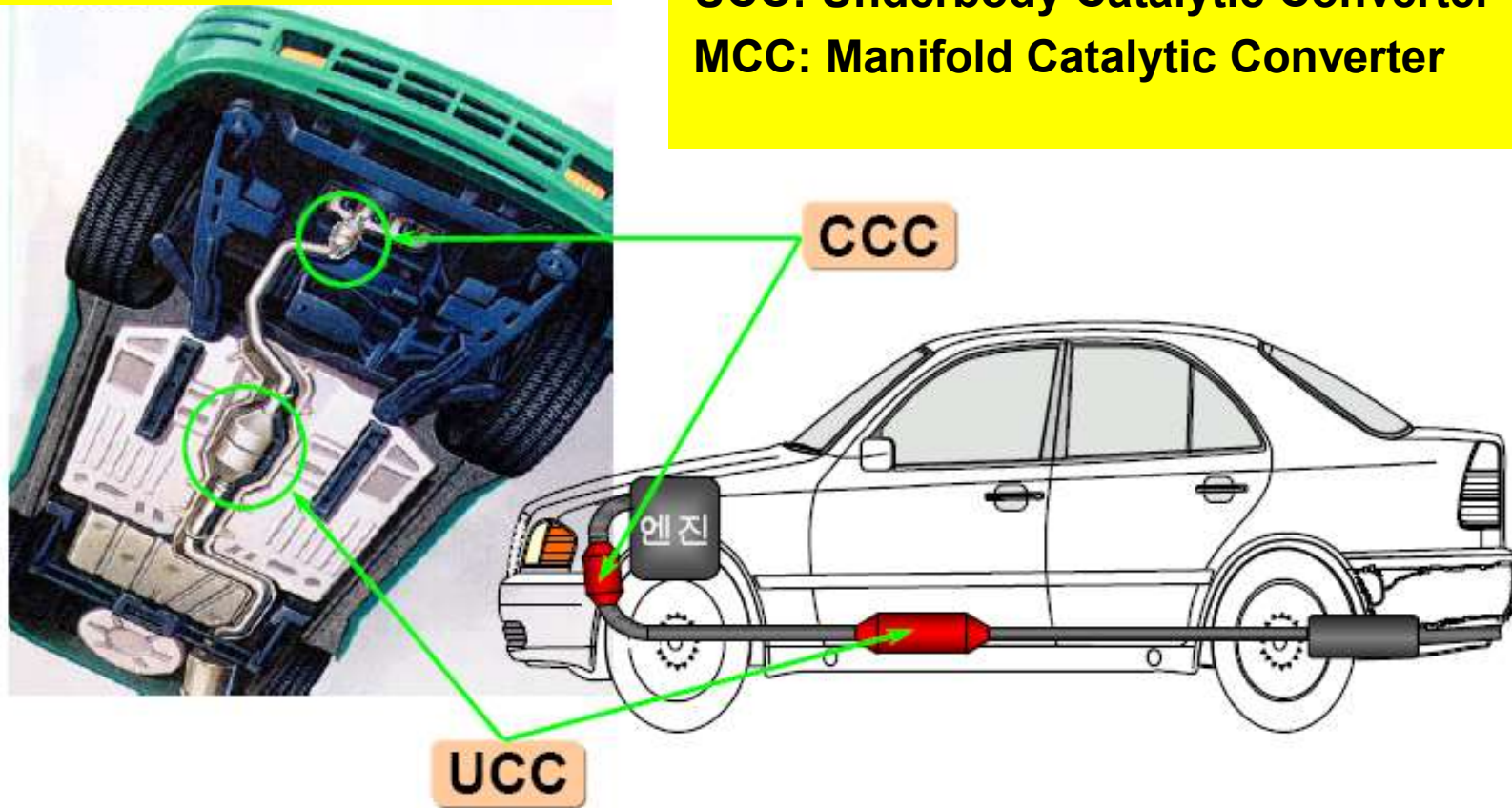

UCC → CCC → **CCC + UCC**

Monolith Types for TWCs

Ceramic monolith: Cordierites ($2\text{MgO}\cdot 2\text{Al}_2\text{O}_3\cdot 5\text{SiO}_2$)

Metallic monolith: Stainless steel (75% Fe - 20% Cr - 5% Al)

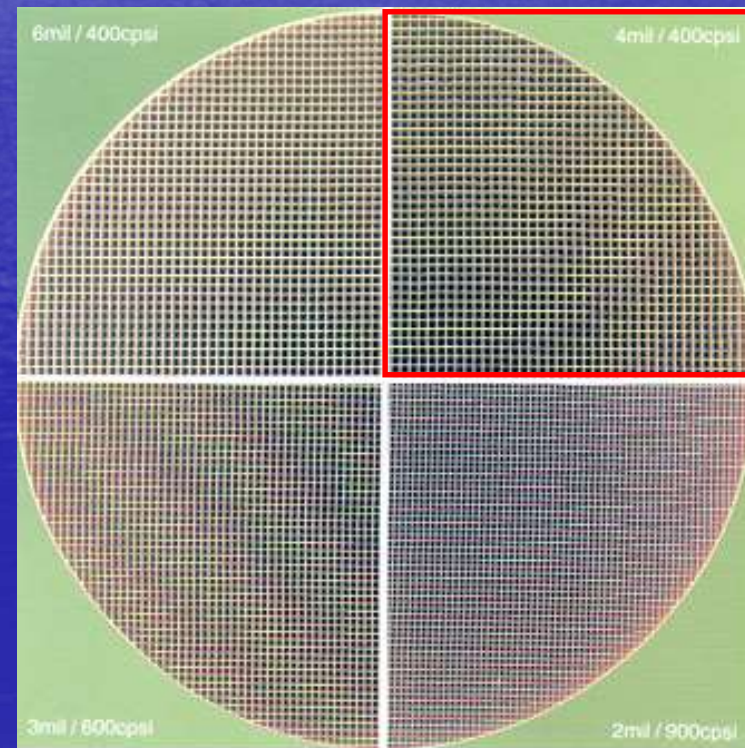
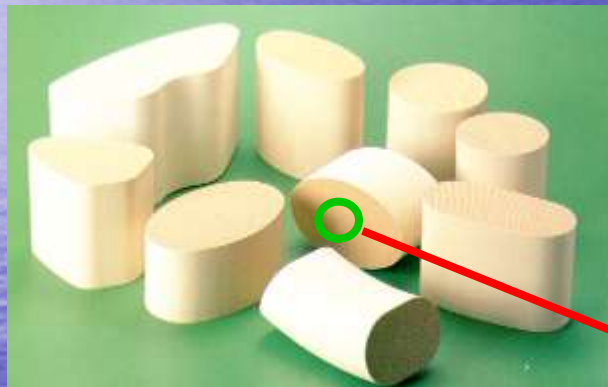

Active Ingredients of TWCs

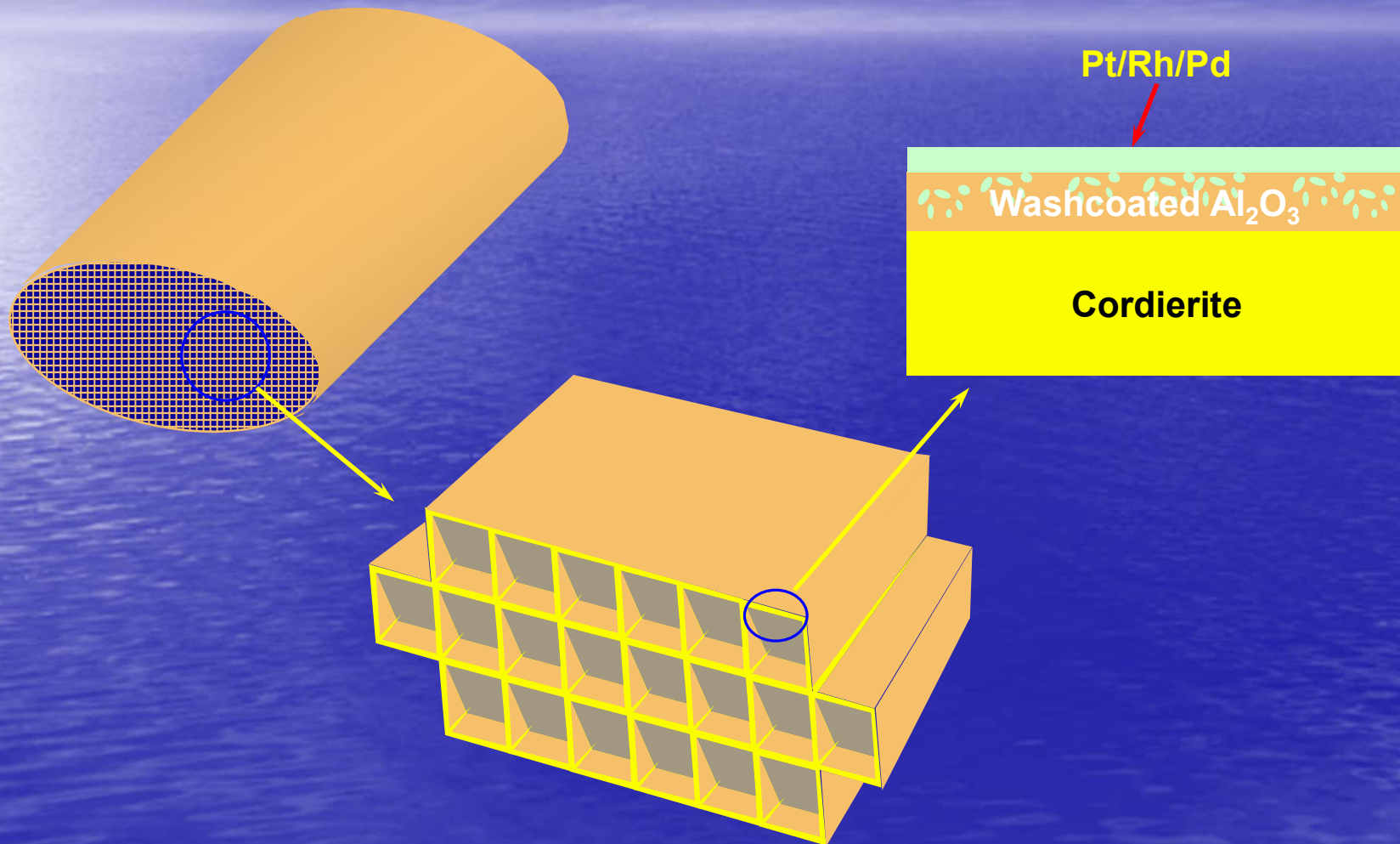

Representative Configuration of TWCs

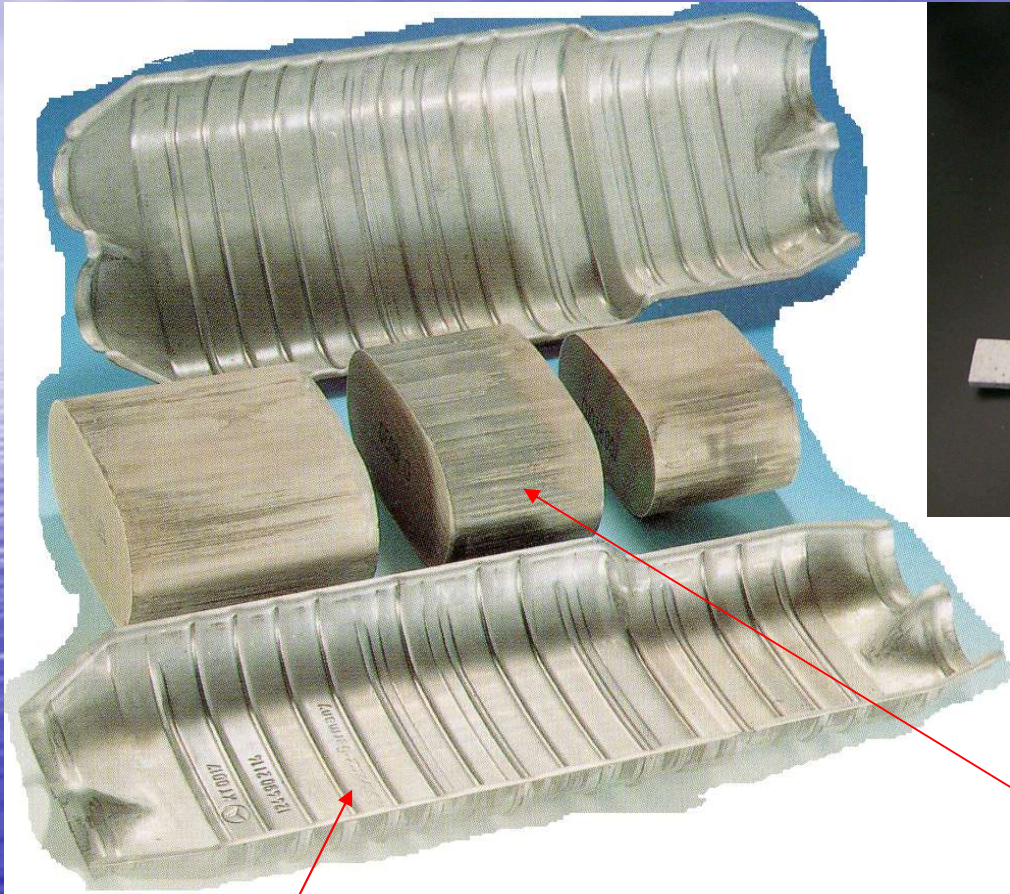

Can

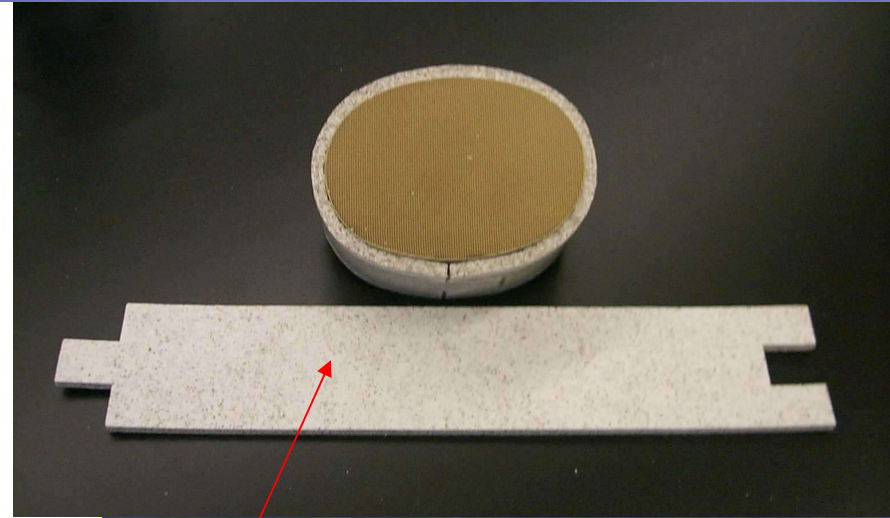

Mat

Honeycomb support

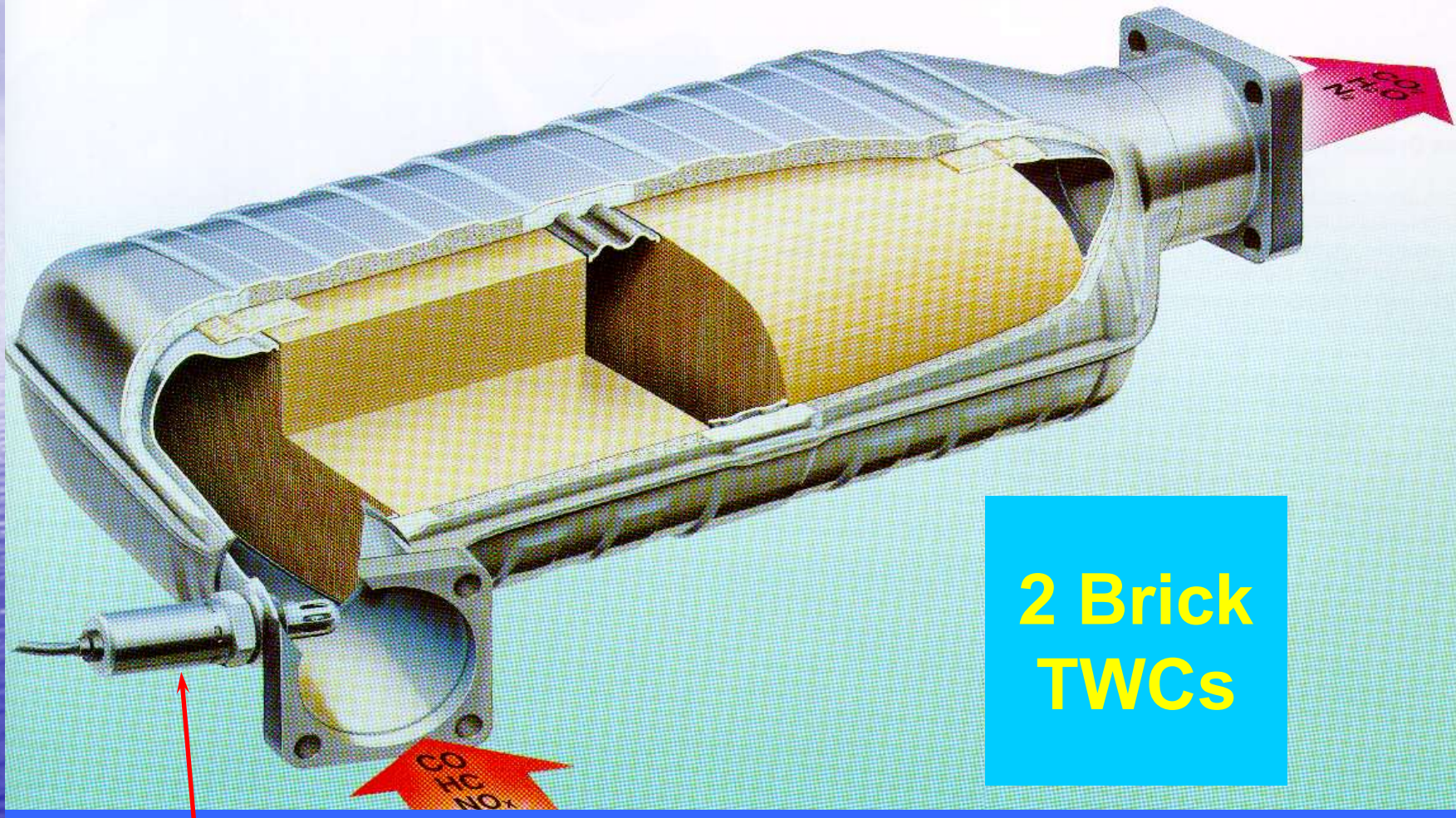

λ sensor

2 Brick
TWCs

NO_x Storage/Reduction Catalysts (NSR)



NO_x Storage

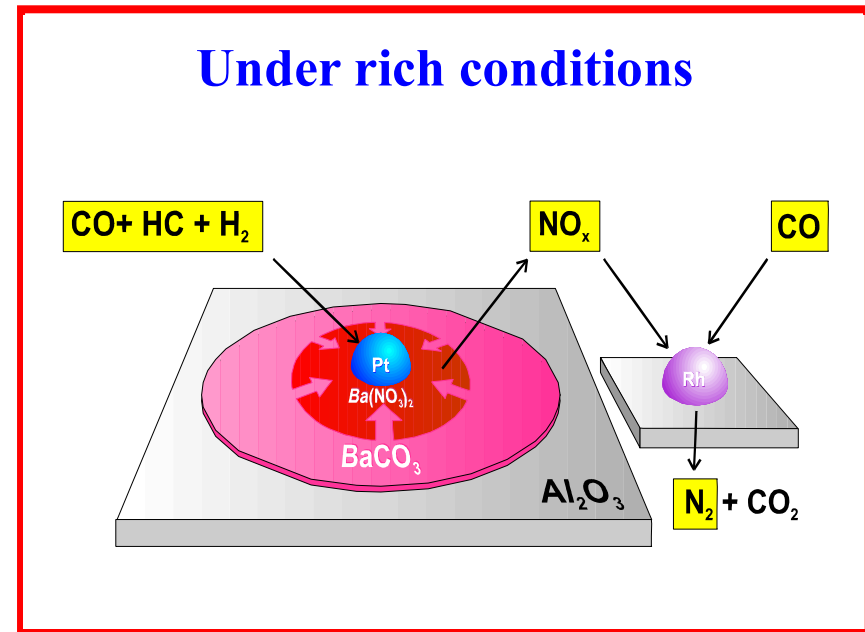

NO_x Reduction

A Pt/BaO/Al₂O₃ catalyst is typically used to store NO_x under oxidizing conditions as adsorbed “nitrate” species, which are then released and reduced on a traditional TWC upon temporarily running GDI engines under rich conditions.

Typical Position of NSR for GDI Engines

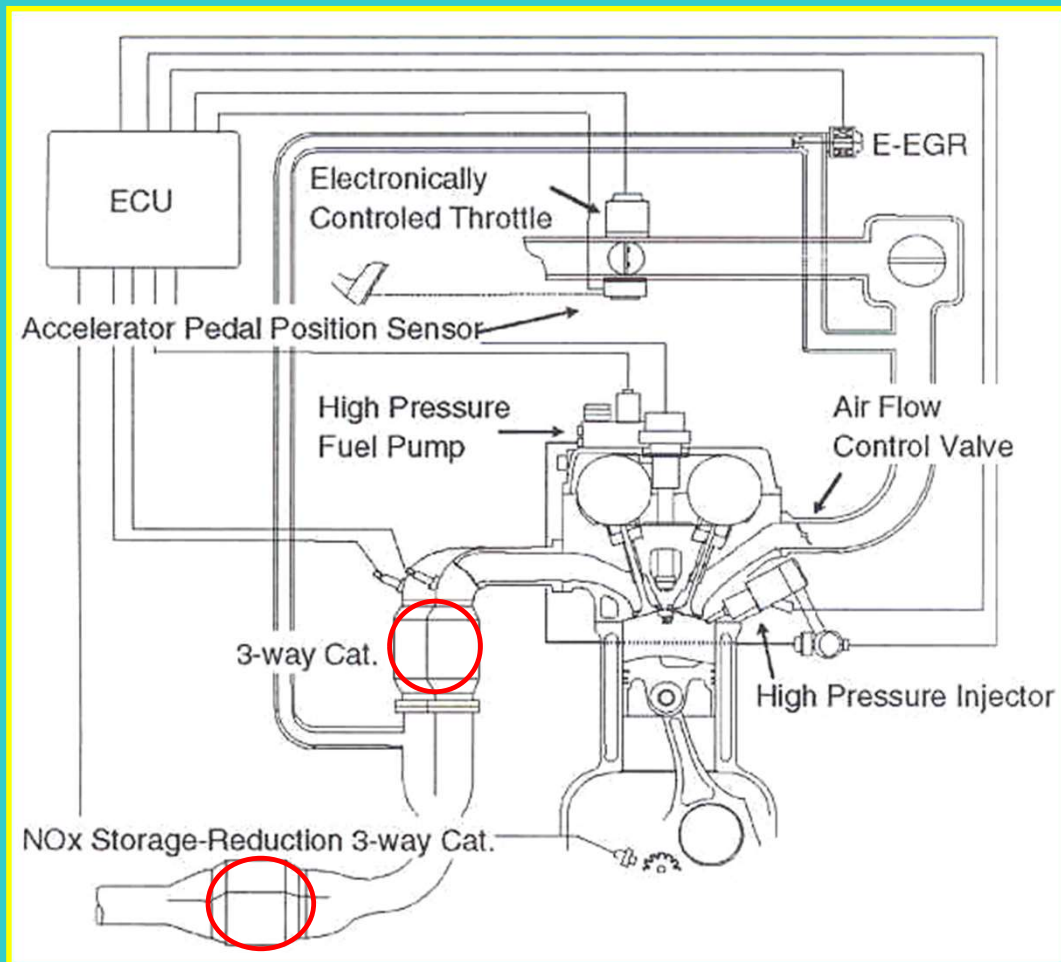

NSR catalysts are fitted to gasoline direct injection (GDI) engine-equipped vehicles.

The GDI engines were first developed by the Mitsubishi Motors in 1996, but the Toyota Motors launched commercially such engines.

Diesel Catalytic Converters: DOCs

Pt-based catalysts are commonly used for this DOCs.

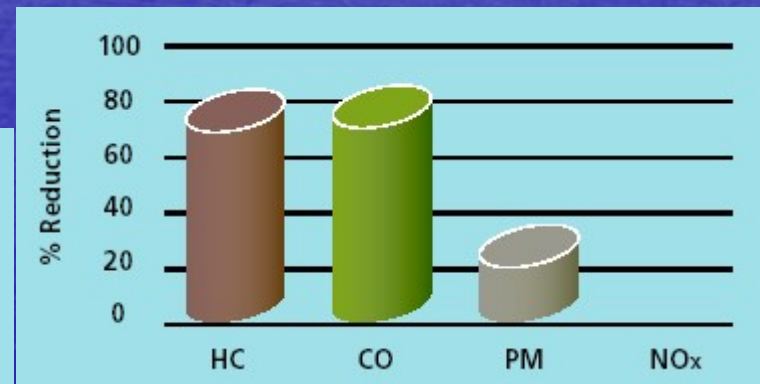

Diesel oxidation catalysts (DOCs)

Diesel Catalytic Converters: DPFs and CPFs

Exhaust gas enters the blocked channels and is forced through porous walls - Soot materials are trapped on the walls.

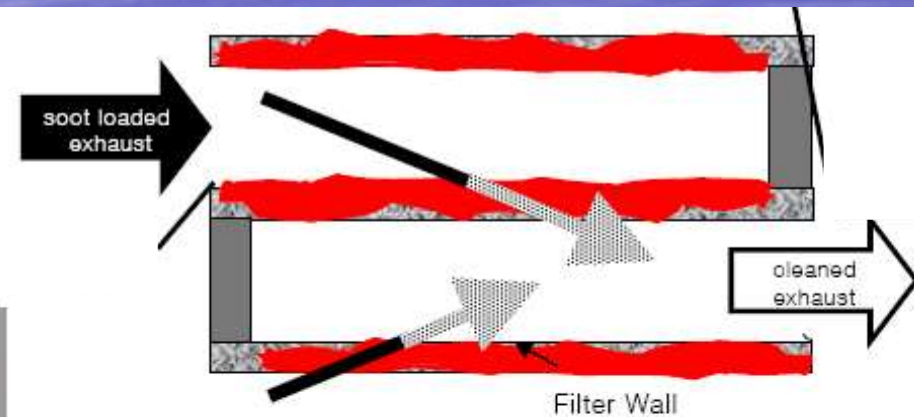
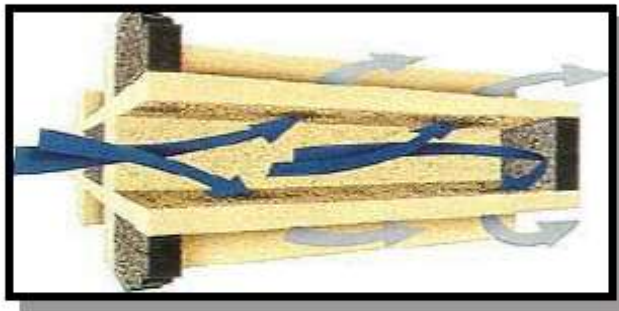

Silicon carbide(SiC)



Cordierite



Regeneration of DPFs and CPFs

☞ Regeneration Approaches

- *Continuous regeneration, e.g. CRT™ or catalyzed filter*
- *Active regeneration*

☞ Active regeneration via O₂-soot reaction @ T > 600°C

- *Electrical heating*
- *Exhaust temperature management, e.g. VVT*
- *Warm-up DOC – NO oxidation to NO₂ improves PM combustion*

Diesel Catalytic Converters: DOC/D(C)PFs

Pt-based catalysts are commonly used for this DOC/DPFs.

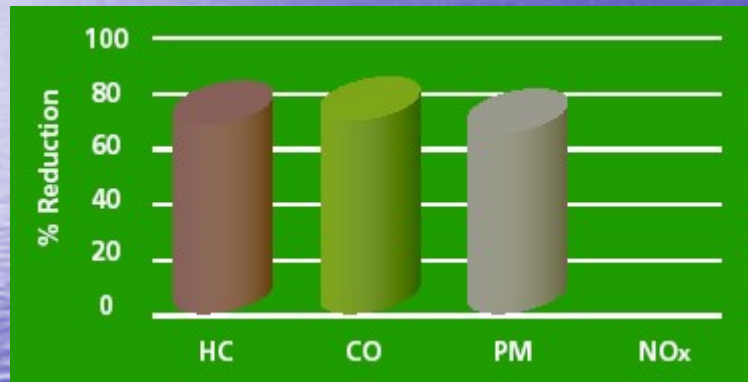

- Working @ $T > 250^{\circ}\text{C}$.
- Subsequent need of DeNO_x control systems.
- Need of ultra low sulfur diesel fuels (<50 ppm).
- Periodic regeneration to remove soot

Diesel Particulate Filter (DPF)

